

GESTALTUNGSELEMENTE

POLLER UND PFLANZKÜBEL



 **kronimus**[®]













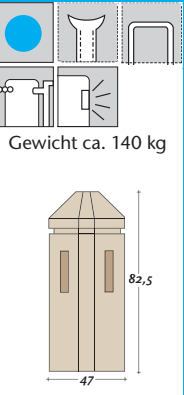

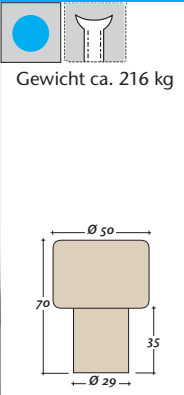

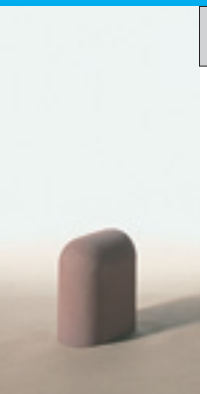
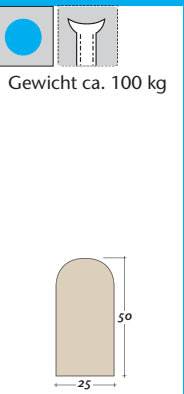

POLLER-ABGRENZUNGEN IN IHRER SCHÖNSTEN FORM

Poller sind massive Wegweiser, schützende Grenzwächter und Wellenbrecher für Fahrspur, Parkbucht, Fahrradweg und Bürgersteig. Sie müssen sich als wohlgeformte, plastische Elemente genauso harmonisch in das Bild der Stadtlandschaft und in die Gestaltung öffentlicher Räume einbinden wie Fassadendetails in die Architektur der Gebäude. Auch im privaten Bereich werden Poller als unübersehbare und zugleich ästhetische Abgrenzung eingesetzt. Dementsprechend groß ist der Formenreichtum des Kronimus Pollerprogrammes. Aber auch die individuellen Wünsche des Planers werden, wo immer möglich, erfüllt. Ebenso vielfältig sind die Möglichkeiten an Oberflächenausführungen und Sonderanfertigungen.

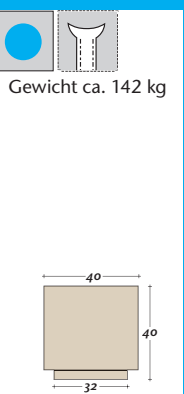

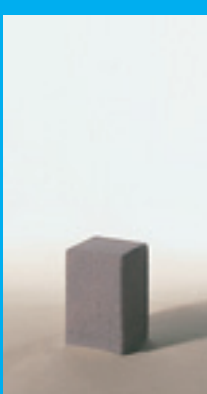

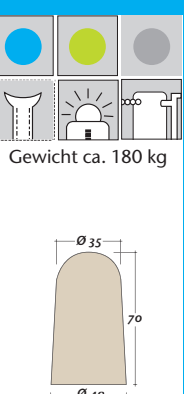
EINER SCHÖNER WIE DER ANDERE

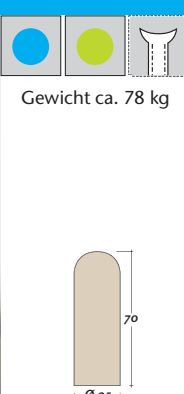
<p>TYP NUSSLOCH 1</p>   <p>Gewicht ca. 140 kg</p>	<p>TYP NUSSLOCH 2</p>   <p>Gewicht ca. 140 kg</p>	<p>TYP PFORZHEIM</p>   <p>Gewicht ca. 216 kg</p>
<p>KLEINER BAUMSCHUTZPOLLER</p>   <p>Gewicht ca. 31 kg</p>	<p>TYP TAUNUS</p>   <p>Gewicht ca. 100 kg</p>	<p>TYP ODENWALD</p>   <p>Gewicht ca. 305 kg</p>
<p>SECHSKANTPOLLER</p>   <p>Gewicht ca. 140 kg</p>	<p>KLEINER QUADERPOLLER</p>   <p>Gewicht ca. 142 kg</p>	<p>GROSSER QUADERPOLLER</p>   <p>Gewicht ca. 360 kg</p>
<p>RECHTECKPOLLER</p>   <p>Gewicht ca. 102 kg</p>	<p>KEGELPOLLER</p>   <p>Gewicht ca. 180 kg</p>	<p>TYP LAUDA</p>   <p>Gewicht ca. 78 kg</p>

TYP SPEYER



Gewicht ca. 265 kg

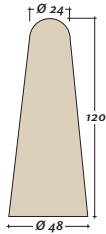

KUGELPOLLER 1



Gewicht ca. 9 kg



Oberflächenausführung

Geringe Farbabweichungen sind drucktechnisch bedingt möglich!

● grau*



● wassergestrahlt*

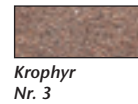

● sandgestrahlt

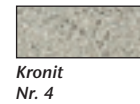
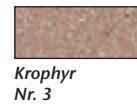
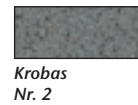

KUGELPOLLER 2



Gewicht ca. 43 kg

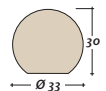

KUGELPOLLER 3



Gewicht ca. 70 kg



KUGELPOLLER 4



Gewicht ca. 200 kg

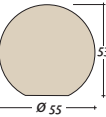

KUGELPOLLER 5



Gewicht ca. 590 kg



Verankerung der Poller



Ankerhülse M 16



Aussparung 10/10 cm



Anschlussbewehrung
Ø 8 mm

TYP KARLSRUHE I



Gewicht ca. 84 kg

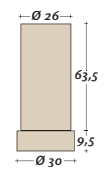

TYP KARLSRUHE II



Gewicht ca. 194 kg



Sonderanfertigungen



Einbetonieren von durchgehenden Leerrohren für Kabel Ø 50, 80, 100 mm



Aussparungen für Lampen im Poller



Verkürzte Anfertigung des Pollers











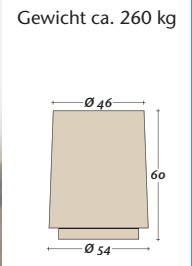

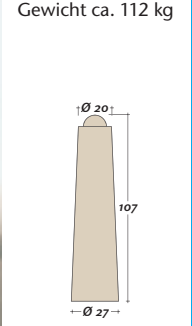
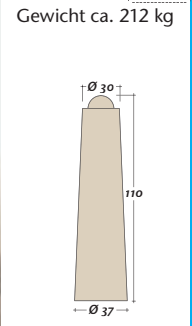

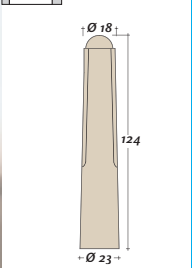





Seitliche Ankerhülsen M 16 zur Befestigung von Ketten oder Geländern

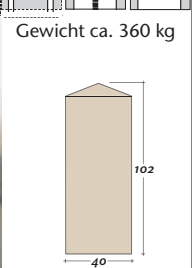

Werkseitig angebrachte Reflektoren/Reflektorringe

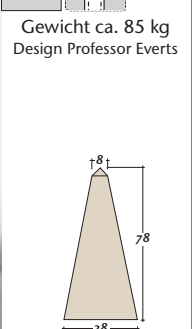
POLLER OHNE ENDE

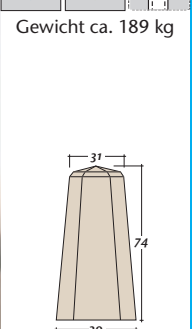
<p>ZYLINDERPOLLER</p>   <p>Gewicht ca. 260 kg</p> 	<p>TYP BASILIKA 1</p>   <p>Gewicht ca. 112 kg</p> 	<p>TYP BASILIKA 2</p>   <p>Gewicht ca. 212 kg</p> 
<p>TYP BADEN-BADEN</p>   <p>Gewicht ca. 116 kg</p> 	<p>TYP WEITERSTADT</p>   <p>Gewicht ca. 460 kg</p>	<p>HALMAPOLLER</p>   <p>Gewicht ca. 170 kg Design Professor Everts</p> 
<p>TYP OBERHOFFEN</p>   <p>Gewicht ca. 260 kg</p> 	<p>TYP MEMMINGEN</p>   <p>Gewicht ca. 360 kg</p> 	<p>TYP SCHWALBACH</p>   <p>Gewicht ca. 455 kg</p> 
<p>TRAPEZPOLLER</p>   <p>Gewicht ca. 153 kg</p> 	<p>PYRAMIDENPOLLER</p>   <p>Gewicht ca. 85 kg Design Professor Everts</p> 	<p>TYP FRANKREICH 1</p>   <p>Gewicht ca. 189 kg</p> 

TYP OOSTAAL

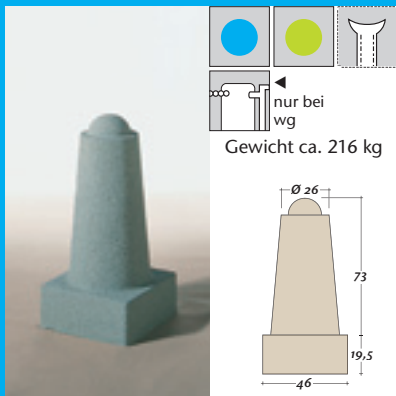

TYP NAGOLD 1

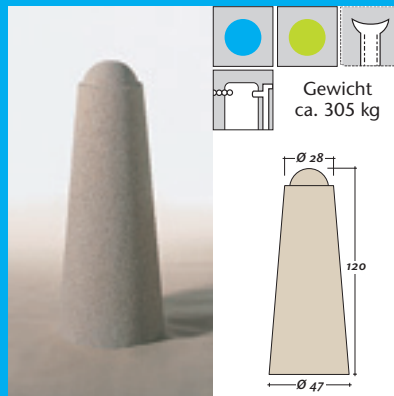

Oberflächenausführung

Geringe Farbabweichungen sind drucktechnisch bedingt möglich!

● grau*



● wassergestrahlt*

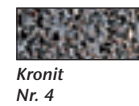
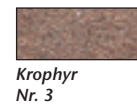

● sandgestrahlt

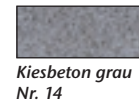
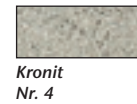
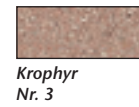
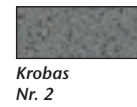

TYP NAGOLD 2

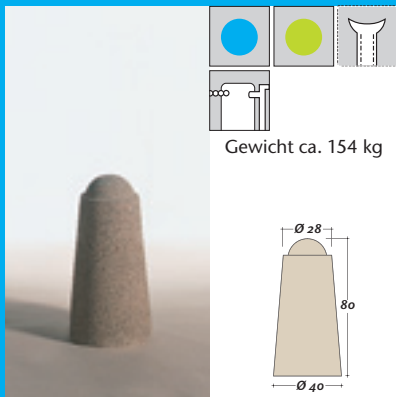

TYP KINZIGTAL

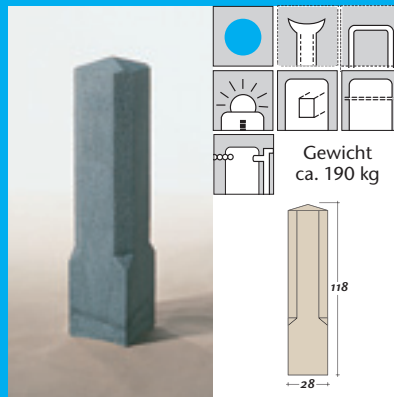

TYP WALLIS

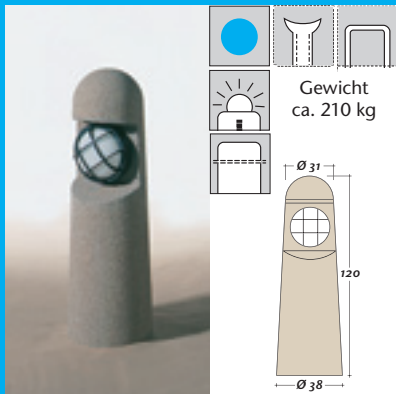

TYP WALLIS MIT SOCKEL



Verankerung der Poller



Ankerhülse M 16



Aussparung 10/10 cm



Anschlussbewehrung
ø 8 mm

SL-POLLER

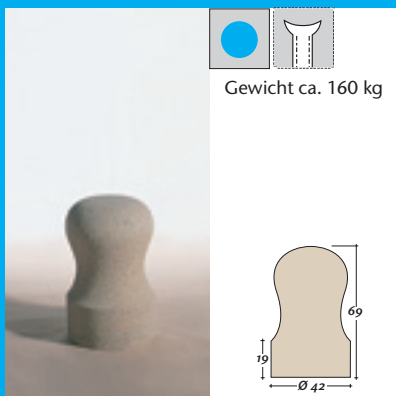

FAHRRADABSTELL-POLLER

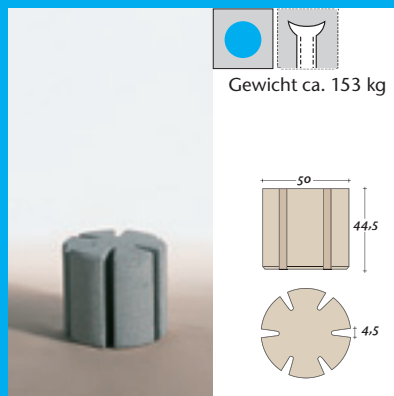

Sonderanfertigungen



Einbetonieren von durchgehenden Leerrohren für Kabel ø 50, 80, 100 mm



Aussparungen für Lampen im Poller



Verkürzte Anfertigung des Pollers



Seitliche Ankerhülsen M 16 zur Befestigung von Ketten oder Geländern



Werkseitig angebrachte Reflektoren/Reflektorringe

PFLANZKÜBEL — MOBILE PFLANZENPRACHT

Unverwüstlich und vielfältig in Formen und Einsatzmöglichkeiten sind Pflanzkübel und -tröge aus Beton. Sie sind ideal für die Stadtgestaltung, für die Terrasse, Vorplatz und Garten. Aber auch als lustig plätschernder Brunnen, begrünter Poller, Bankauflager oder blühender Fahrbahnteiler werden diese Pflanzelemente eingesetzt. Ein Wasserabfluss sorgt für die Feuchtigkeitsregulierung und gute Wachstumsbedingungen.

Die frostbeständigen Behälter haben teilweise innenseitige Ankerhülsen für das Versetzen. Sie können auf Wunsch auch mit geschlossenem oder ohne Boden, sowie mit Brunnenwassersäule geliefert werden. Durch die sandgestrahlte Oberflächenausführung wirken sie natürlich und elementar.

Oberflächenausführung:

Geringe Farbabweichungen sind drucktechnisch bedingt möglich.

● sandgestrahlt



Krophyr
Nr. 3



Kronit
Nr. 4



Jurakronit
Nr. 309



SERIE KRONOS – WIE VON HAND BEHAUEN

KRONOS TYP 1



Gewicht 67 kg
Pflanztiefe 14 cm

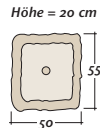

KRONOS TYP 2



Gewicht 48 kg
Pflanztiefe 14 cm

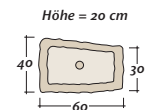

KRONOS TYP 3



Gewicht 52 kg
Pflanztiefe 14 cm

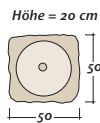

KRONOS TYP 4



Gewicht 200 kg
Pflanztiefe 33 cm

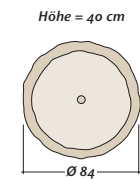

KRONOS TYP 5



Gewicht 83 kg
Pflanztiefe 17 cm

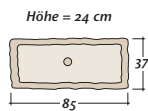

KRONOS TYP 6



Gewicht 233 kg
Pflanztiefe 53 cm

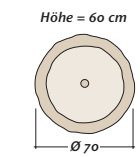

KRONOS TYP 7



Gewicht 825 kg
Pflanztiefe 50 cm

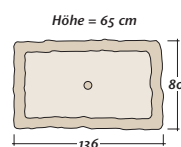

LEONBERG



Gewicht 250 kg
Pflanztiefe 48 cm
Design City-Serie

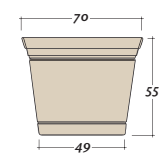

CITY-SERIE – KLARE GEOMETRISCHE FORMEN

MÜLLHEIM



Gewicht 1195 kg
Pflanztiefe 50 cm

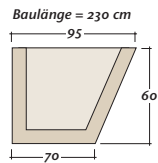

BAD HERRENALB



Ø in cm	Gewicht (kg)	Pflanztiefe (cm)
80	360	40
100	430	40
120	760	40
150	1000	40
200	1400	40

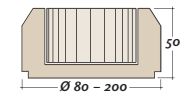

BADEN-BADEN TYP 1



Gewicht 998 kg
Pflanztiefe 65 cm



BADEN-BADEN TYP 2



Gewicht 445 kg
Pflanztiefe 40 cm

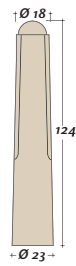

FREUDENSTADT



Gewicht 450 kg
Pflanztiefe 50 cm

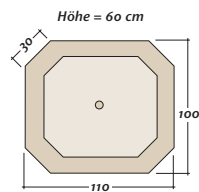

GÖPPINGEN



L/B/H	Gewicht (kg)	Pflanztiefe (cm)
100/50/60	290	50
120/60/60	340	50
100/100/60	380	50
120/120/60	680	50



ETTLINGEN



Gewicht 720 kg
Pflanztiefe 39 cm

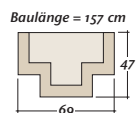

KARLSRUHE



Gewicht 620 kg
Pflanztiefe 50 cm

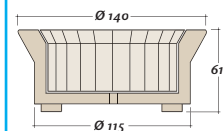



www.kronimus.de

Hauptverwaltung

Kronimus AG
 Betonsteinwerke
 Industriegebiet
 76473 Iffezheim
 Tel. 0 72 29 / 69 - 0
 Fax 0 72 29 / 69 - 1 99
 info@kronimus.de

Kronimus AG
 Betonsteinwerke
 Schafhauser Straße
 71106 Magstadt
 Tel. 0 71 59 / 49 01
 Fax 0 71 59 / 4 32 08
 info@kronimus.de

Kronimus AG
 Betonsteinwerke
 Industriestraße 9
 79258 Hartheim
 Tel. 0 76 33 / 9 08 98 - 0
 Fax 0 76 33 / 9 08 98 - 16
 info@kronimus.de

Kronimus GmbH & Co. KG
 Betonsteinwerk
 Austraße 169-173
 74076 Heilbronn
 Tel. 0 71 31 / 15 18 - 0
 Fax 0 71 31 / 15 18 - 49
 info@kronimus-heilbronn.de

Kronimus GmbH & Co. KG
 Betonsteinwerk
 Am Saale-Dreieck 1
 39240 Sachsendorf
 Tel. 03 92 94 / 2 70 - 0
 Fax 03 92 94 / 2 70 - 39
 info@kronimus-s-dorf.de

Kronimus S.A.
 Route de Marange
 F-57281 Maizieres-
 Les-Metz
 Tel. 00 33 3 87 80 11 47
 Fax 00 33 3 87 51 63 69
 info@kronimus.fr